



**Faculty of Engineering and Technology
Electrical and Computer Engineering
Department**

**ENEE2102
CIRCUITS LAB**

Student's name: Anas abedelhalim tomaizeh

Student's number: 1152325

Pre lab exp#4

Date 11/10/2017

Eng.: Qais samara

Dr: Hakam shehada

Part one: step response for first order RC circuit:

The circuit:

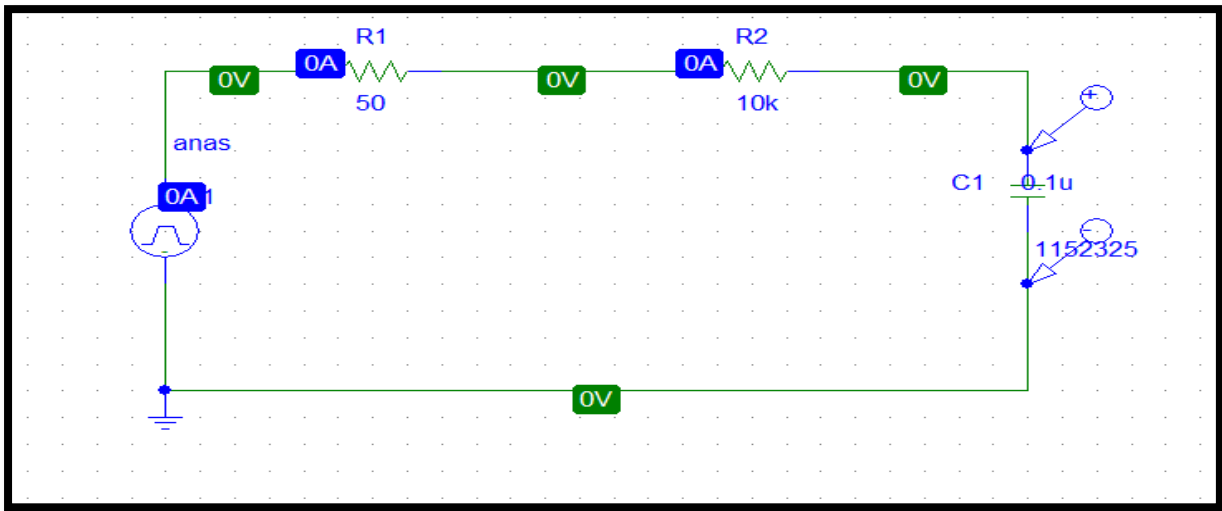

The result:

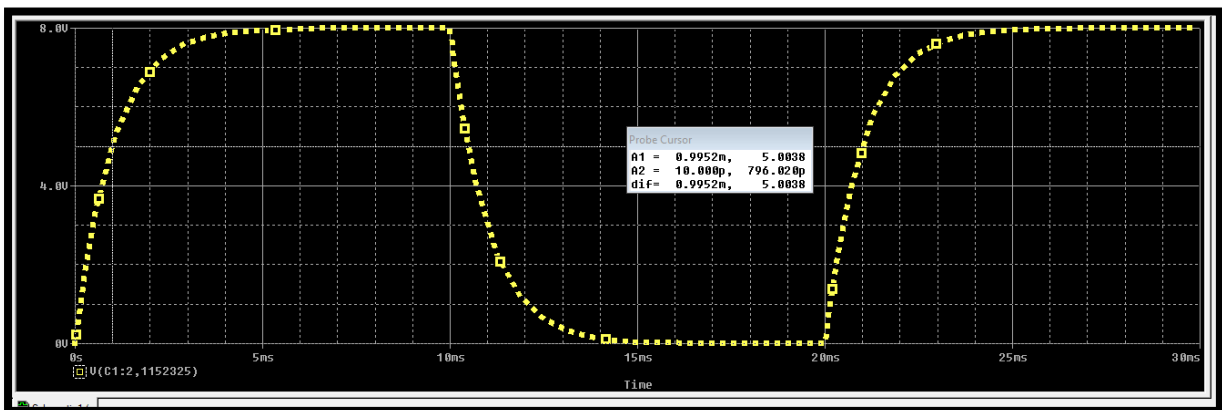

*From the graph, shown above the value of time constant is 1ms.

The circuit:

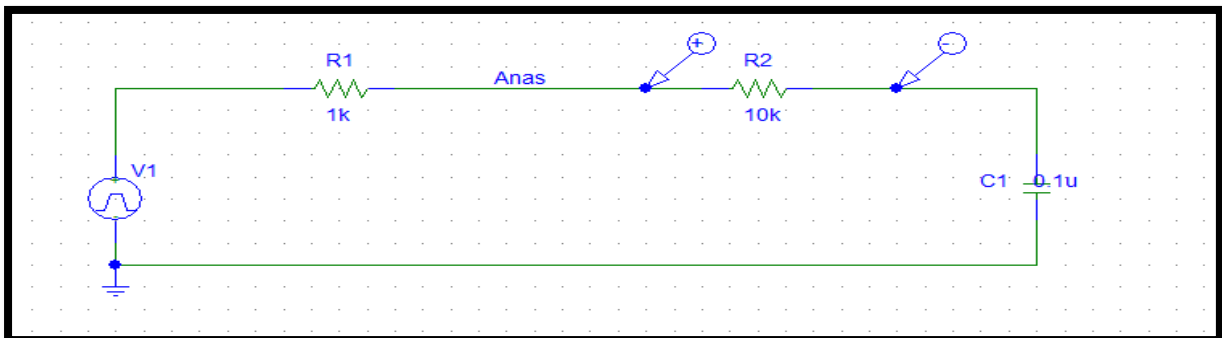

The result:

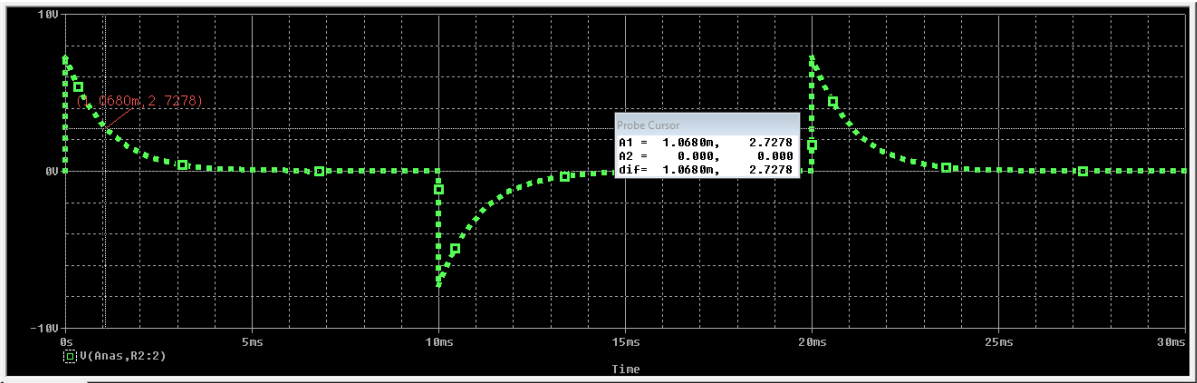

Part two: Step response of First-order RL circuit:

The circuit:

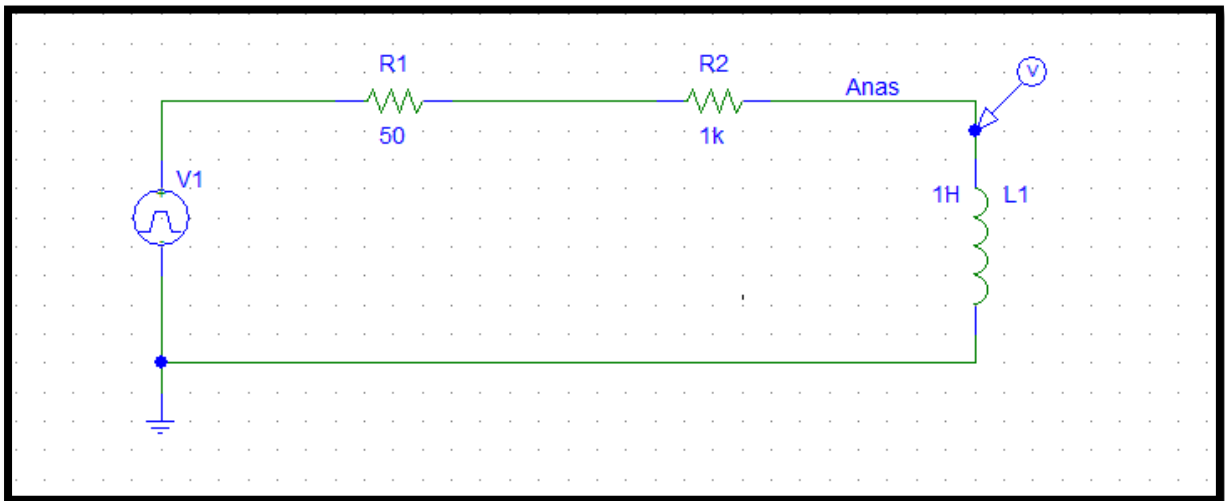

The result:

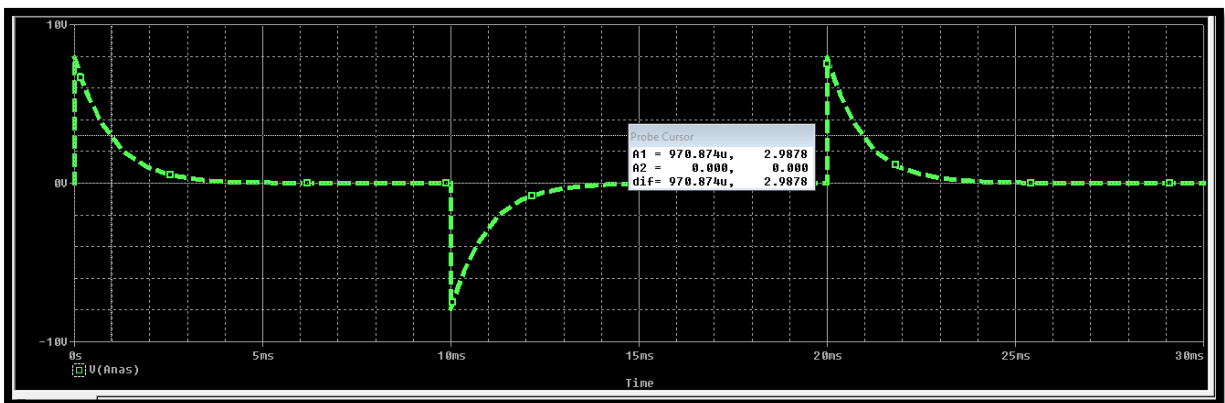

The circuit:

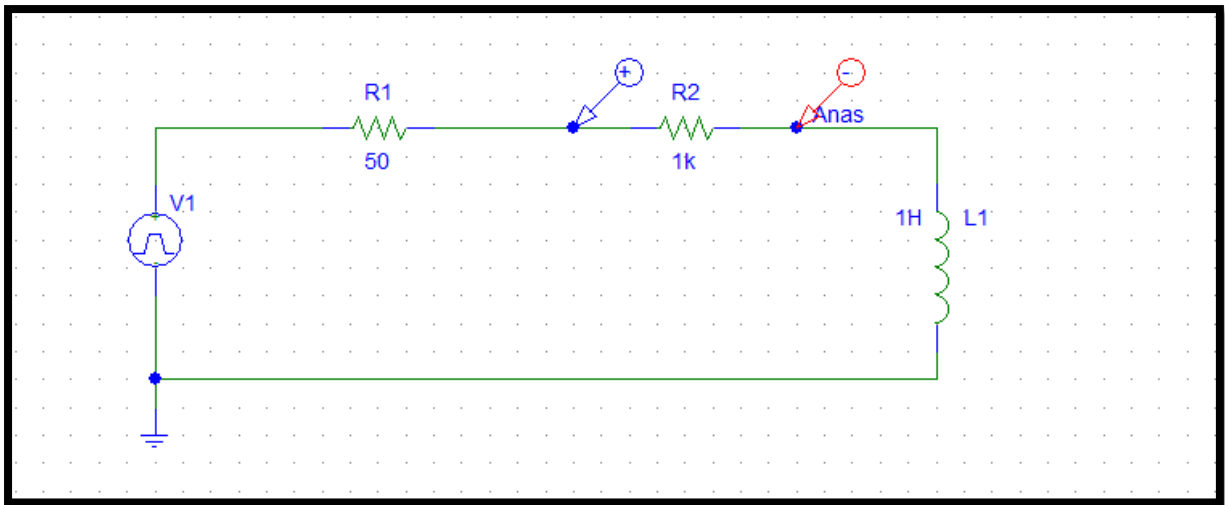

The result:

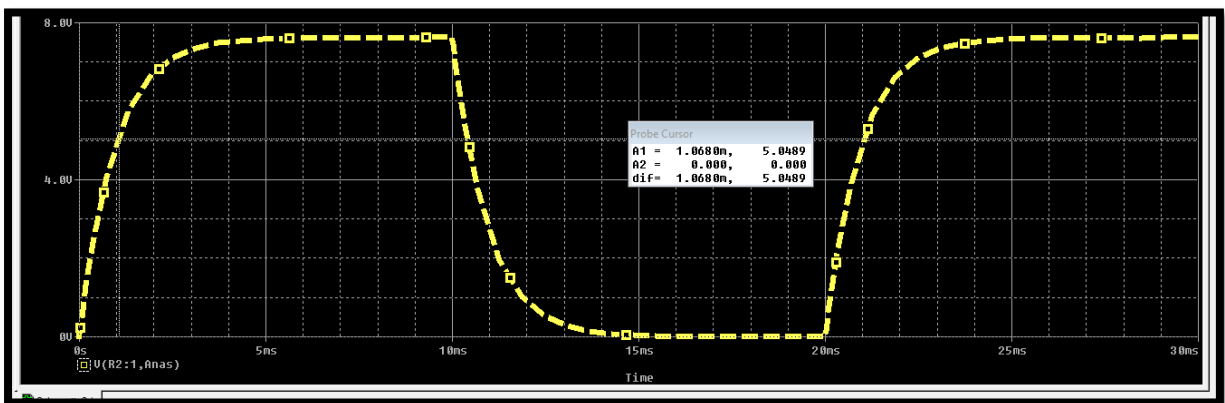

Part c: Step response of second-order Series RLC circuit:

1) The circuit:

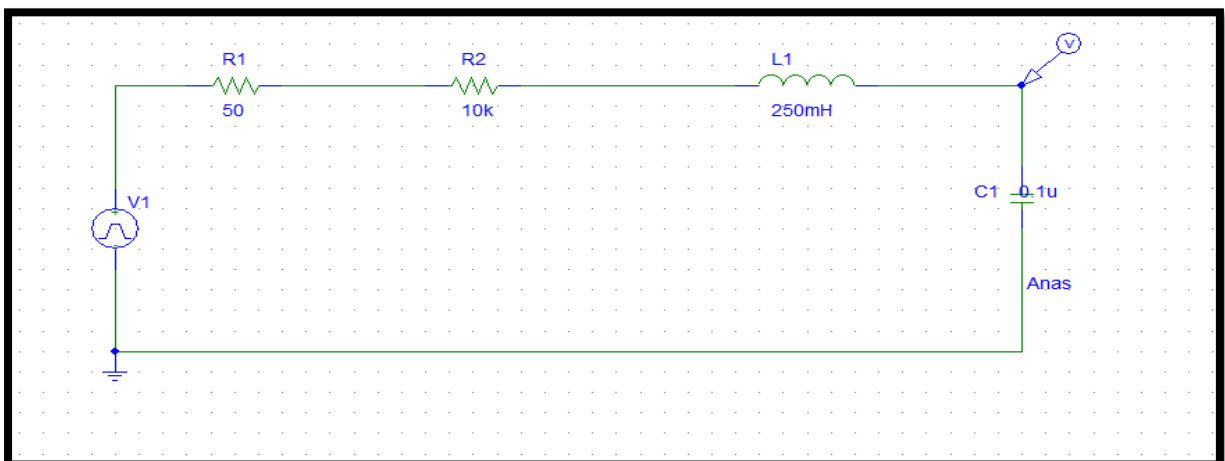

The result:

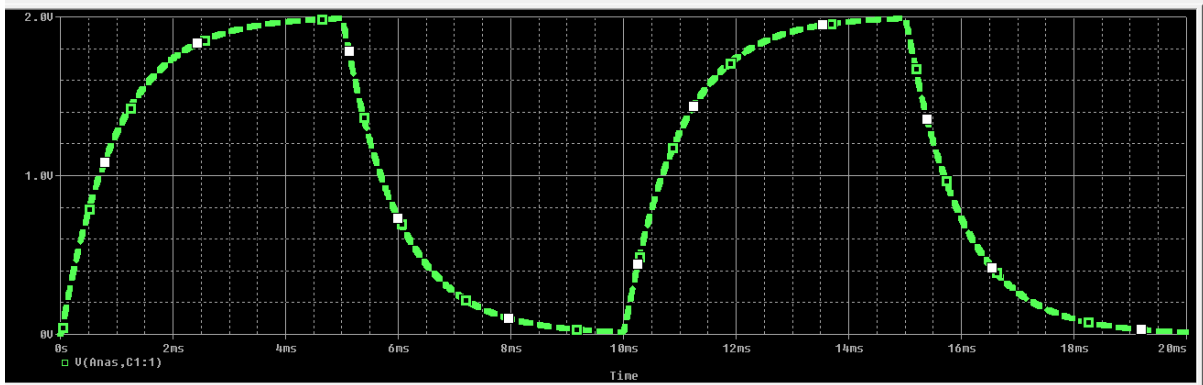

2) The circuit:

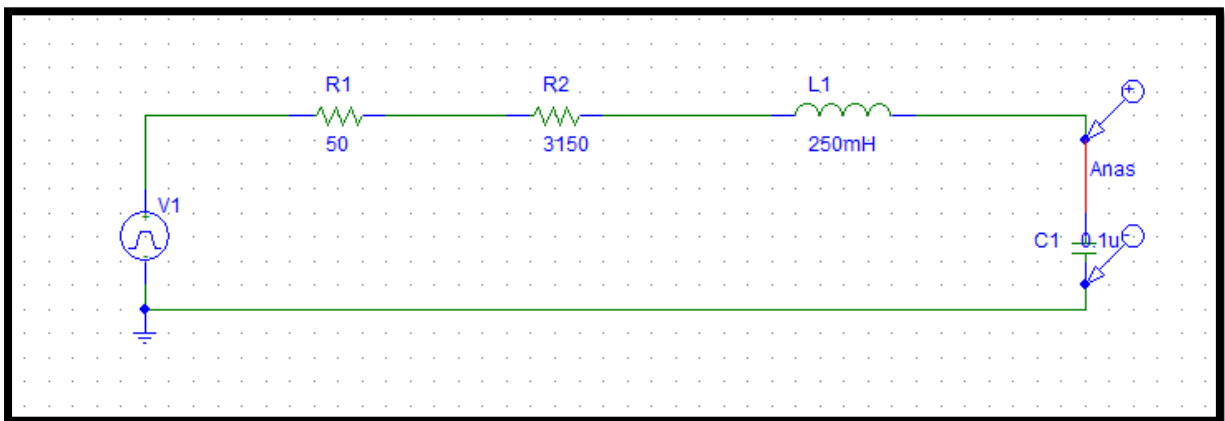

The result:

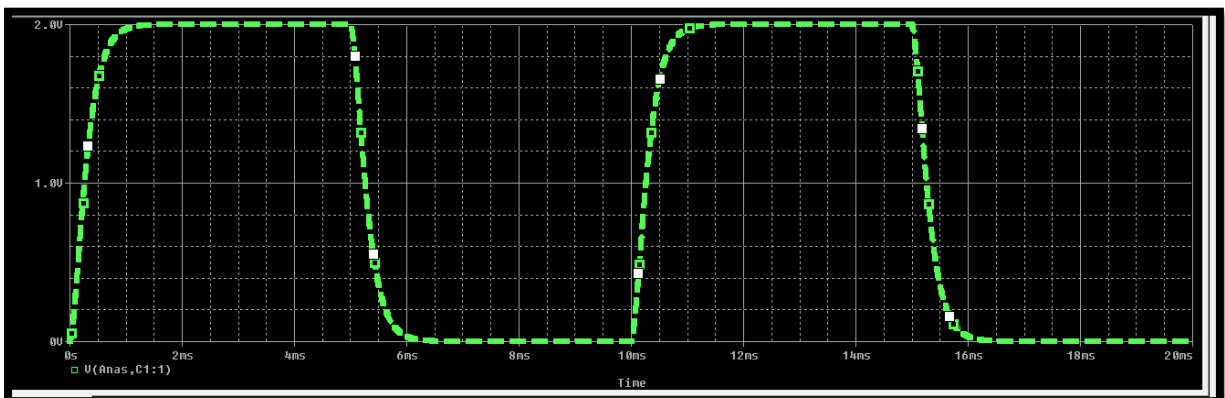

3) The circuit:

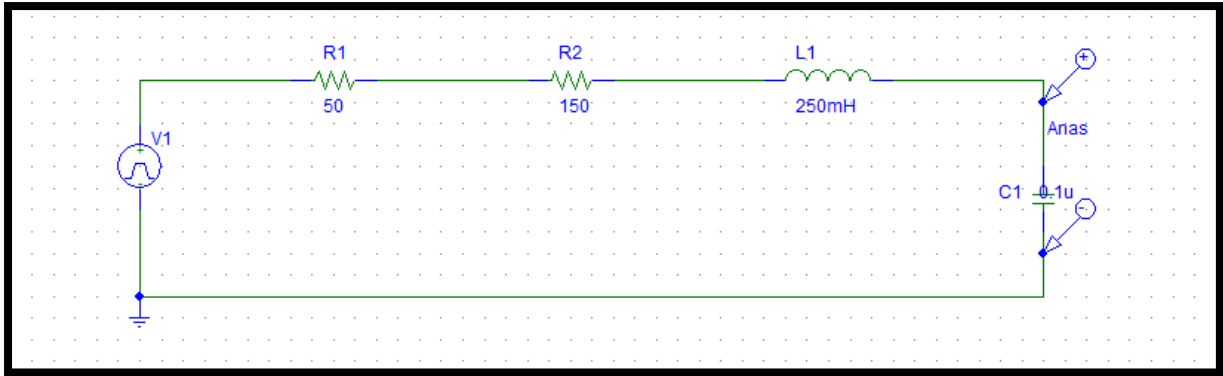

The result:

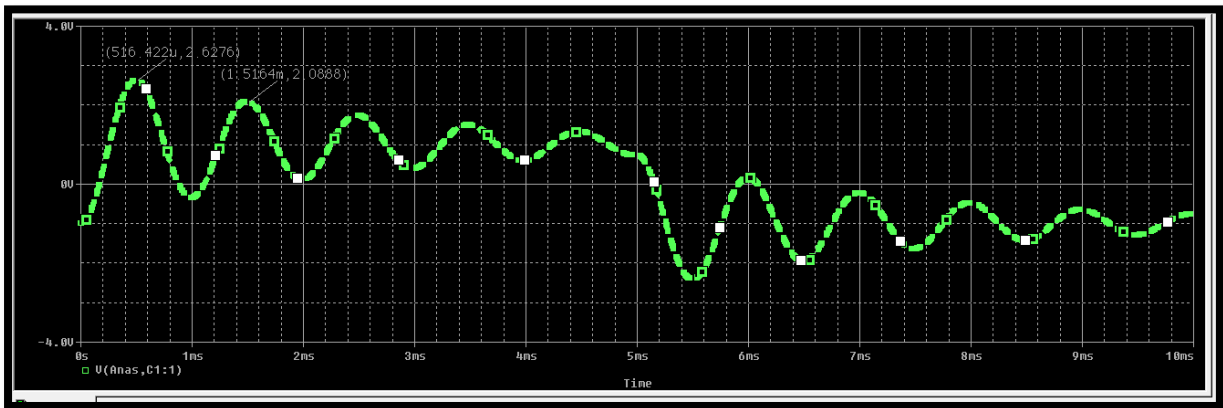

Part D: Step response of second-order parallel RLC circuit

The circuit:

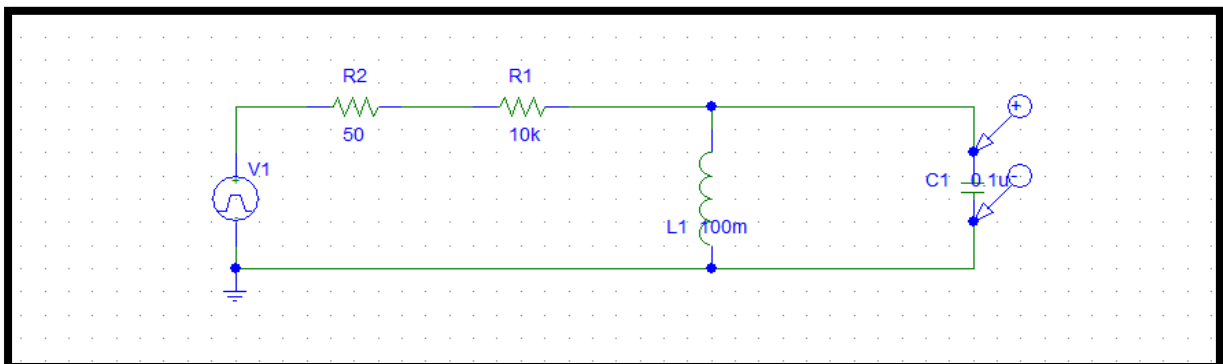

The result:

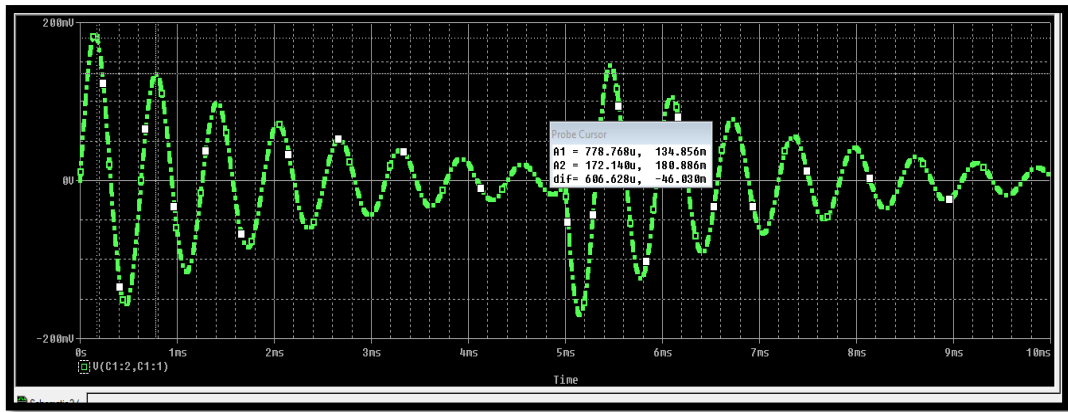

The circuit:

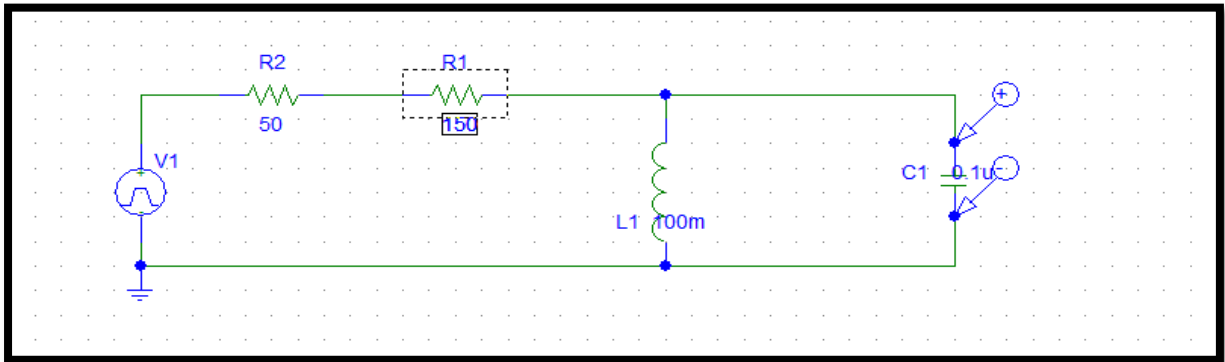

The result:

